

The Scala HDCA-10 is a ruggedly built yagi antenna, designed for professional VHF-TV transmit and receive applications.

Like all Scala antennas, the HDCA-10 is made of the finest materials using state of the art electrical and mechanical designs resulting in superior performance and long service life.

The HDCA-10 may be used stand alone or in stacked arrays for higher gain, increased side-lobe suppression, or custom azimuth patterns.

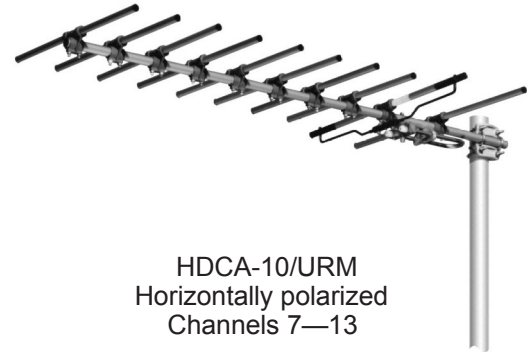

HDCA-10/URM
Horizontally polarized
Channels 7—13

Specifications

Frequency range	Any specified VHF-TV channel 54 to 216 MHz	
Gain	Gain	Power gain
	Channels 2—3	8.75 dBd 7.5
	Channels 4—6	9.5 dBd 8.91
	Channels 7—13	10 dBd 10
Impedance	75 ohms (50 ohms with optional transformer)	
VSWR	<1.5:1	
Polarization	Horizontal or vertical	
Front-to-back ratio	>14 dB	
Maximum input power	250 watts, type "N" 75 ohm termination	
Azimuth pattern	Channels 2—3	50 degrees (half-power)
	Channels 4—6	48 degrees (half-power)
	Channels 7—13	46 degrees (half-power)
Elevation pattern	50 degrees (half-power)	
Connector	75Ω N female	
Weight	34.1 lb (15.5 kg) maximum	
Dimensions	187 x 109 inches maximum (4750 x 2769 mm)	
Wind load at 100 mph (161 kph) Front	HDCA-10/HCM	216 lbf (961 N)
	HDCA-10/HRM	71 lbf (316 N)
	HDCA-10/URM	71 lbf (316 N)
Wind survival rating*	120 mph (193 kph)	
Shipping dimensions	114 x 10 x 6 inches maximum (2896 x 254 x 153 mm)	
Shipping weight	47 lb (21.3 kg)	
Mounting	HDCA-10/HCM	Horizontal polarization center-mount
	HDCA-10/HRM	Horizontal polarization rear-mount
	HDCA-10/URM	Horizontal or vertical polarization rear-mount

*Mechanical design is based on environmental conditions as stipulated in TIA-222-G-2 (December 2009) and/or ETS 300 019-1-4 which include the static mechanical load imposed on an antenna by wind at maximum velocity. Contact KBU for further details.

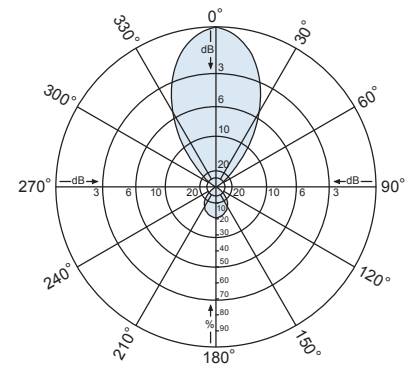

Azimuth pattern (E-plane - typical)

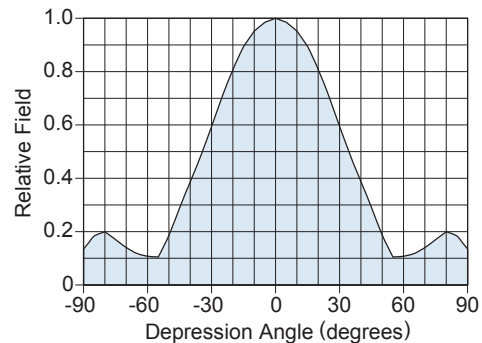

Elevation pattern (H-plane)



A Kathrein Broadcast Brand

HDCA-10 VHF-TV Yagi Antenna 54 to 216 MHz (Channels 2—13)

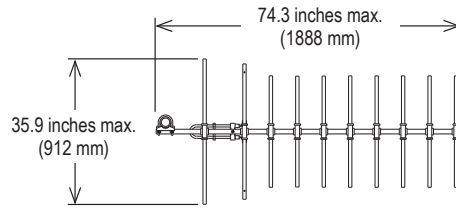

HDCA-10/URM
Horizontal or vertically polarized (rear-mount)
Channels 7—13

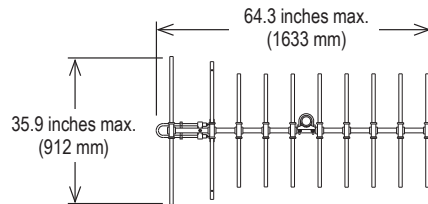
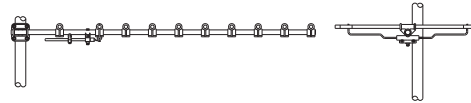

HDCA-10/HCM
Horizontally polarized (center-mount)
Channels 7—13

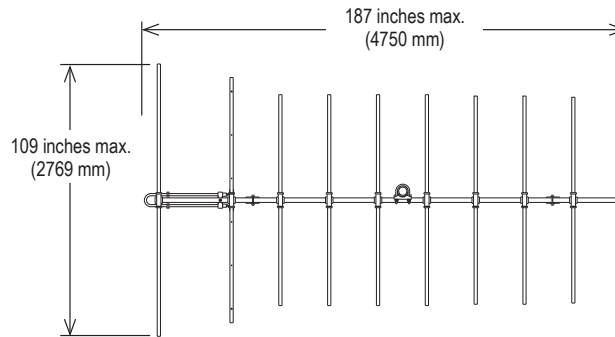
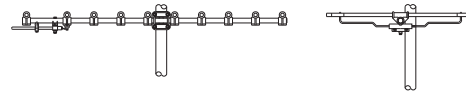

HDCA-10/HCM
Horizontally polarized (center-mount)
Channels 2—6

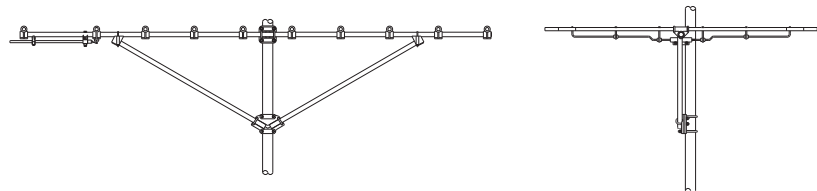

30077a subject to alteration